

9630

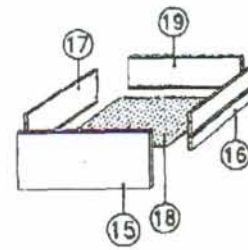

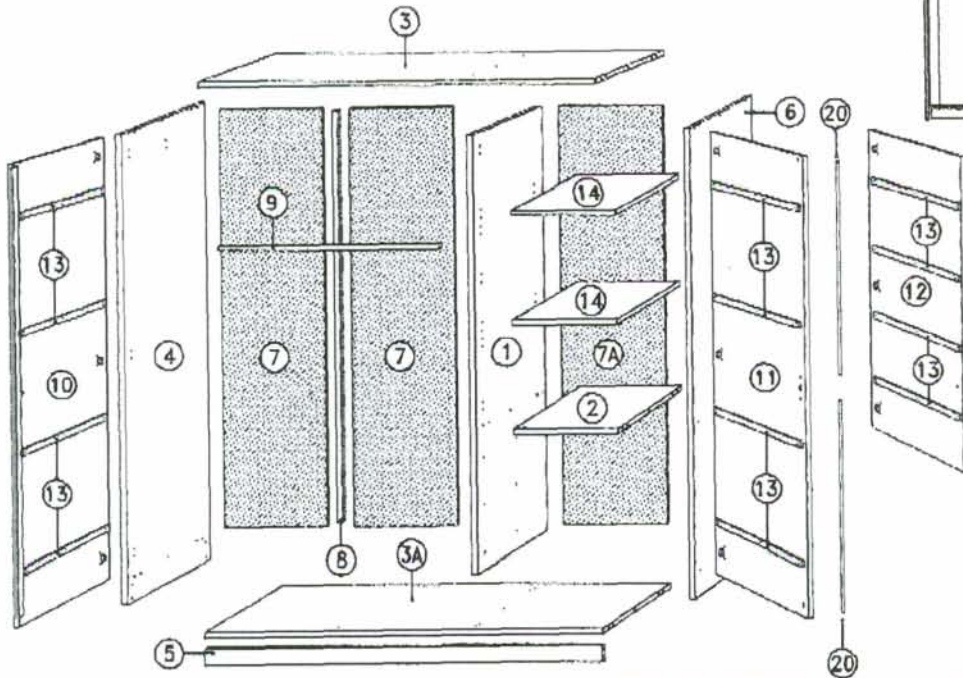





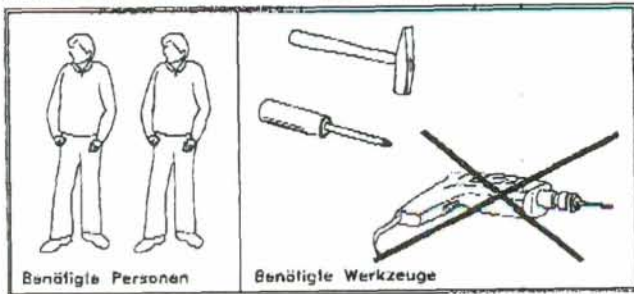

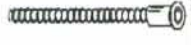







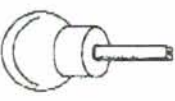

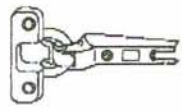





DIE HOLZTEILE THE WOODEN PARTS



X 3

Kollo	Teile-nr.	Anzahl	Mass HxBxT (MM)	✓	Kollo	Teile-nr.	Anzahl	Mass HxBxT (MM)	✓
2-2	①	1	1721 x 535 x 17		2-2	⑩	1	1740 x 485 x 20	
2-2	②	1	475 x 535 x 17		1-2	⑪	1	1740 x 485 x 20	
1-2	③	1	1458 x 535 x 17		2-2	⑫	1	1195 x 485 x 20	
1-2	③A	1	1458 x 535 x 17		1-2	⑬	12	370 x 40 x 16	
2-2	④	1	1833 x 540 x 17		1-2	⑭	2	474 x 525 x 17	
1-2	⑤	1	1458 x 80 x 17		1-2	⑮	3	485 x 178 x 20	
2-2	⑥	1	1833 x 540 x 17		1-2	⑯	3	450 x 118 x 14	
2-2	⑦	2	1750 x 488 x 3		1-2	⑰	3	450 x 118 x 14	
1-2	⑦A	1	1750 x 488 x 3		1-2	⑱	3	445 x 449 x 3	
1-2	⑧	1	1720		1-2	⑲	3	437 x 118 x 14	
1-2	⑨	1	∅ 24 x 957		1-2	⑳	2	835	

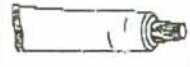

A X 32 <input type="checkbox"/>  Ø8 X 30 MM	B X 24 <input type="checkbox"/>  7 X 50 MM	C X 24 <input type="checkbox"/> 	D X 50 <input type="checkbox"/> 	E X 8 <input type="checkbox"/>  Ø5 MM
F X 6 <input type="checkbox"/>  374 MM		G X 12 <input type="checkbox"/>  5,8 X 11 MM	H X 6 <input type="checkbox"/>  M4 X 11 MM	J X 5 <input type="checkbox"/> 
JJ X 1 <input type="checkbox"/> 	K X 5 <input type="checkbox"/>  4,0 X 45 MM	L X 9 <input type="checkbox"/> 	M X 9 <input type="checkbox"/> 	N X 20 <input type="checkbox"/>  3,5 X 15 MM
P X 12 <input type="checkbox"/>  3,5 X 35 MM	Q X 1 <input type="checkbox"/>  4 MM	R X 2 <input type="checkbox"/> 	S X 2 <input type="checkbox"/> 	T X 36 <input type="checkbox"/>  3,5 X 25 MM
U X 1 <input type="checkbox"/>  	V X 1 <input type="checkbox"/>  OBEN	W X 1 <input type="checkbox"/>  UNTEN	Y X 2 <input type="checkbox"/> 	Z X 2 <input type="checkbox"/> 
1 A X 20 <input type="checkbox"/>  Ø8 X 30 MM		Ø X 2 <input type="checkbox"/> 	Å X 1 <input type="checkbox"/> 	

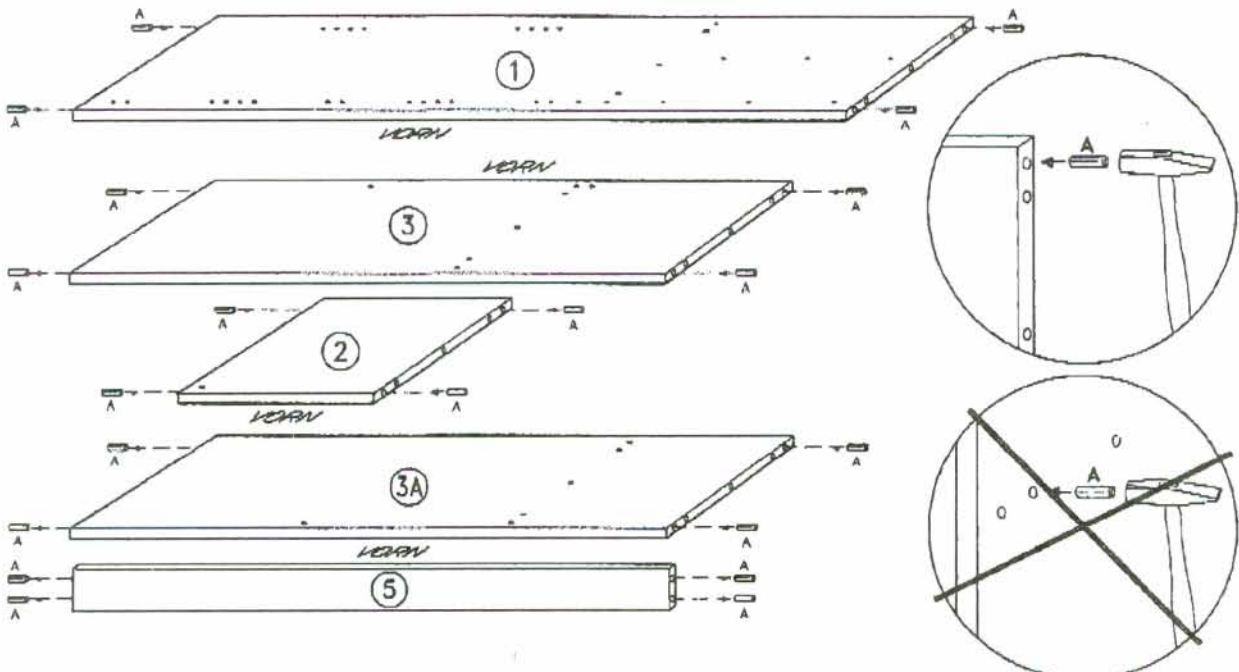

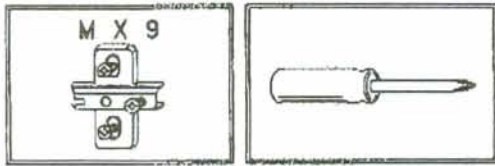

2

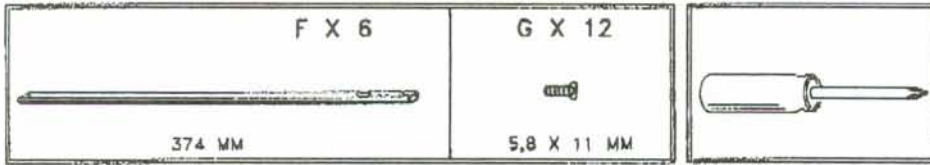
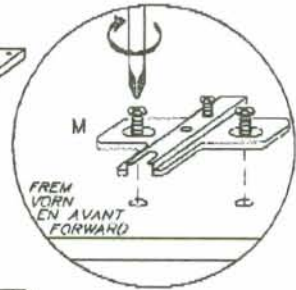
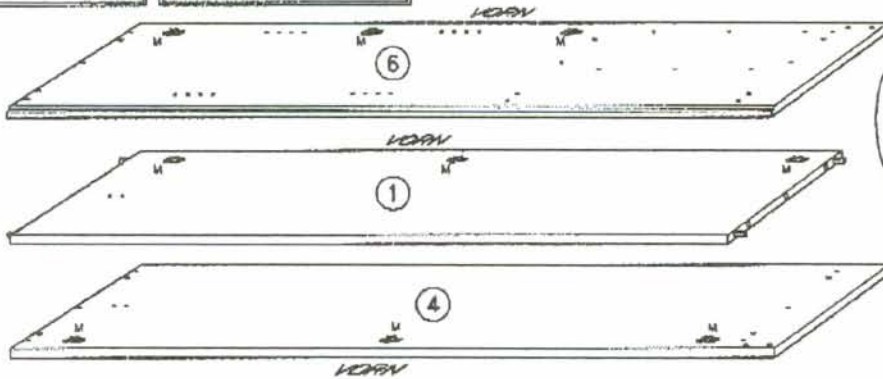

3

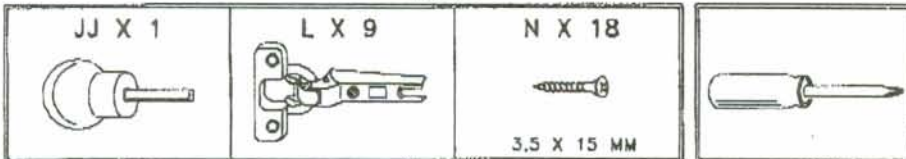
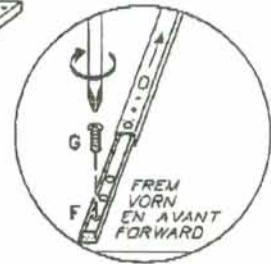
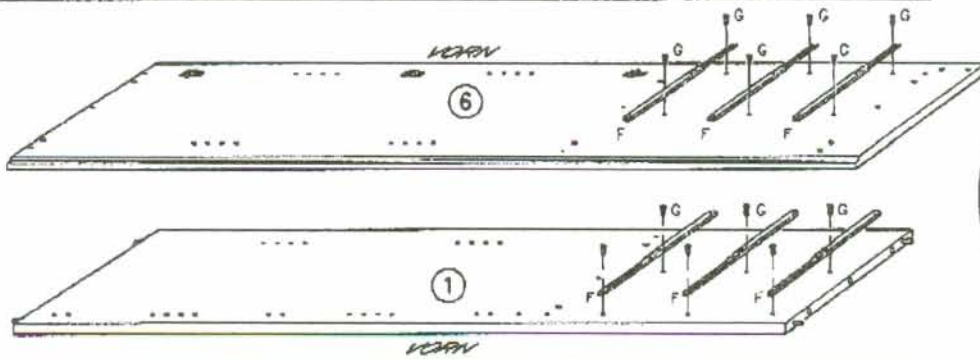

4

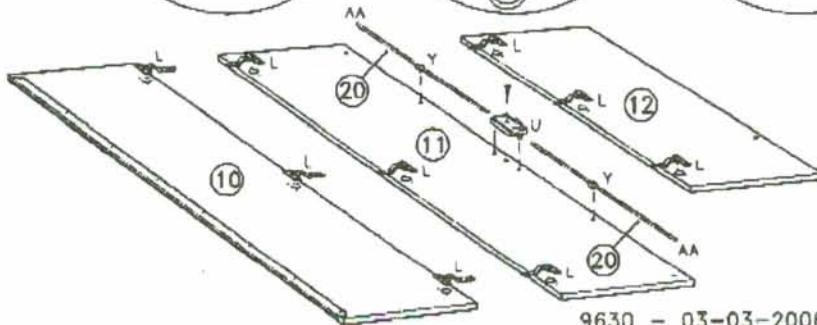
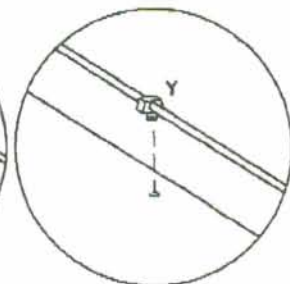
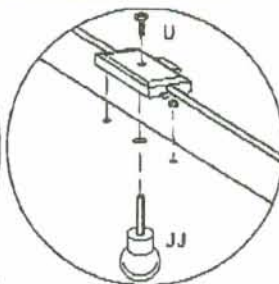
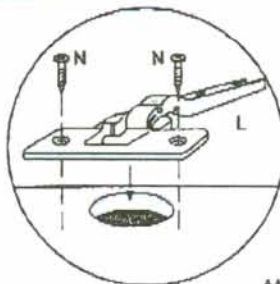
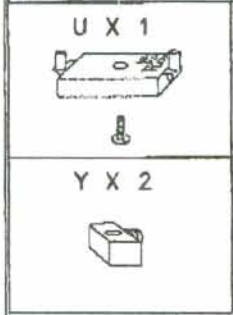



5

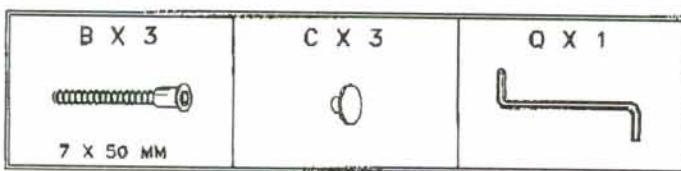
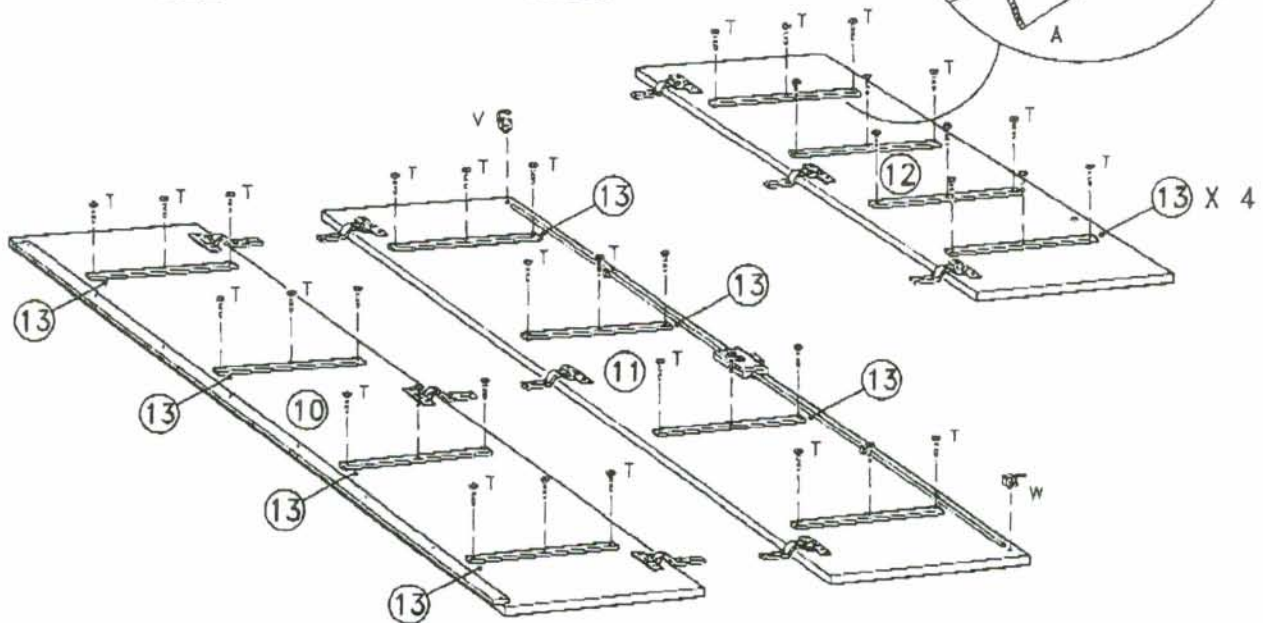
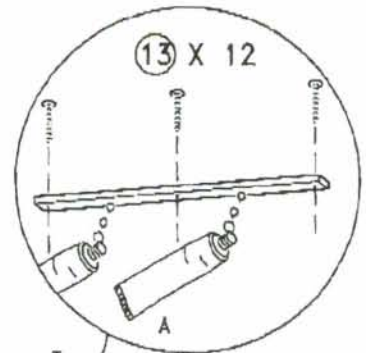
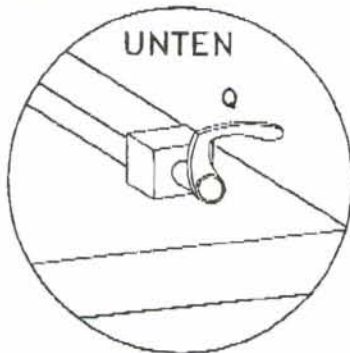
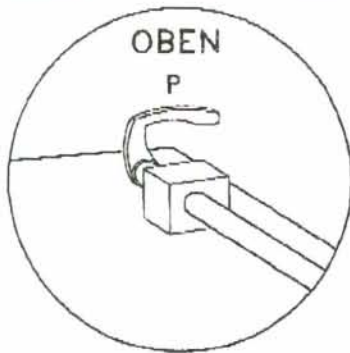

6

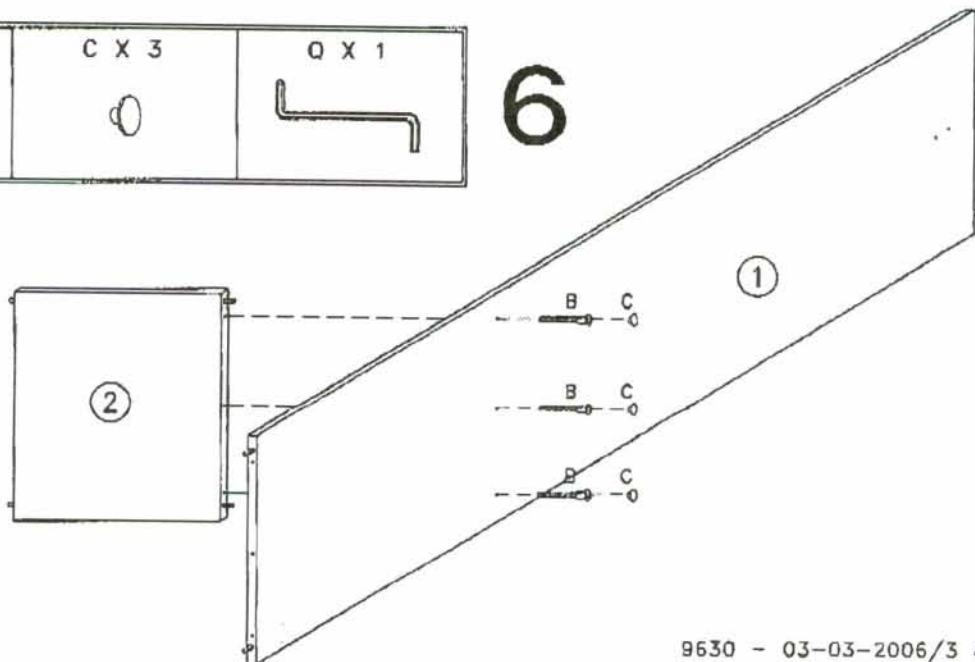

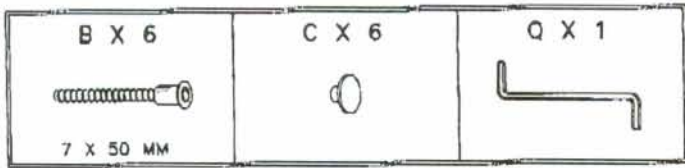

7

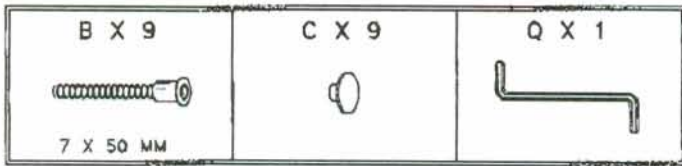
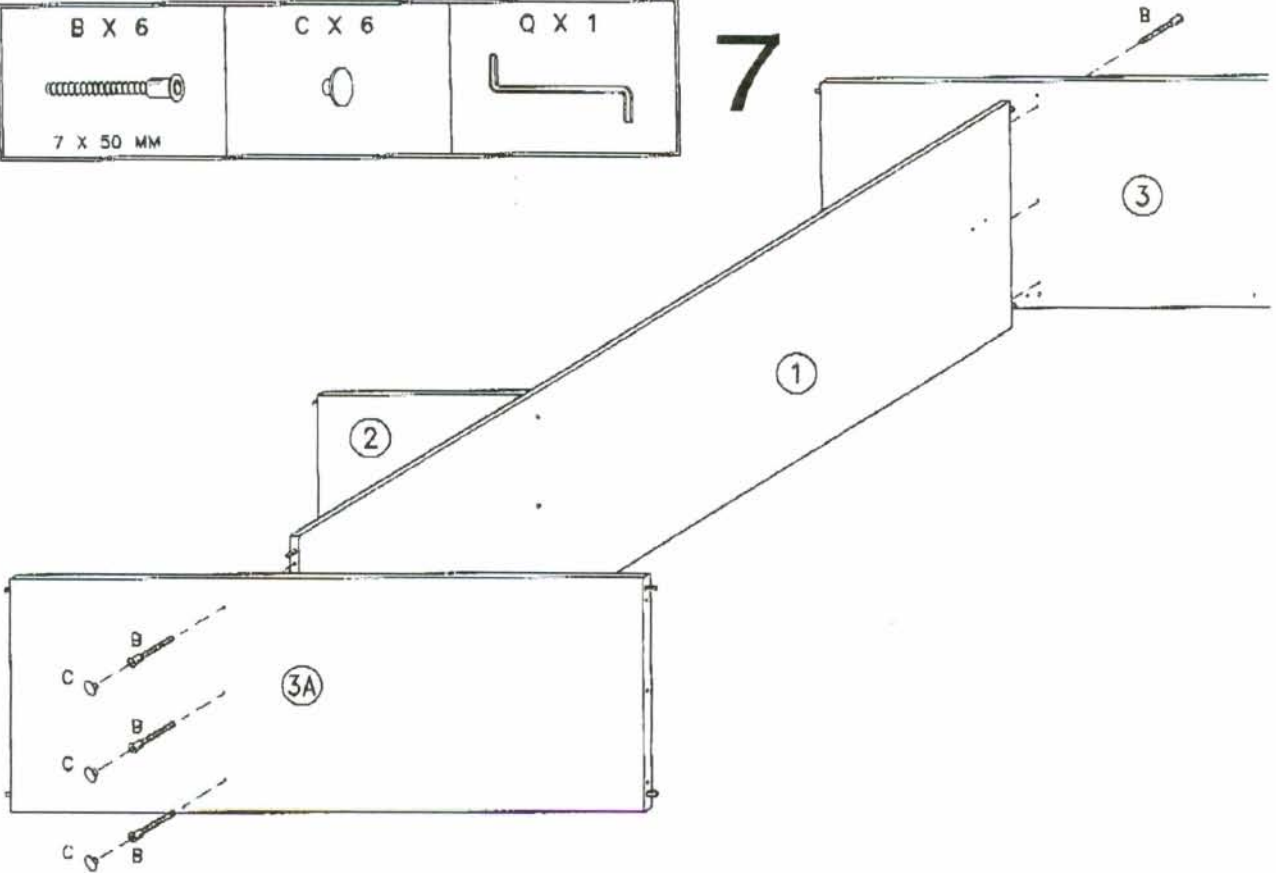

8

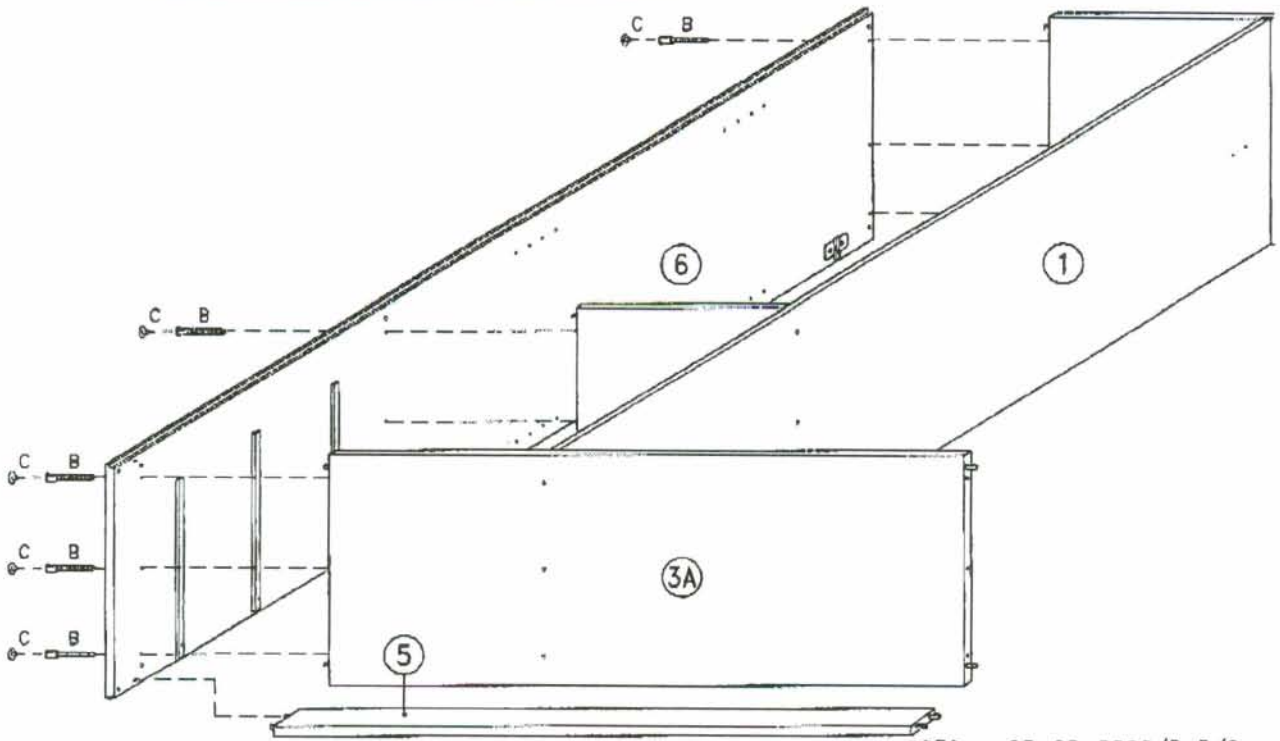

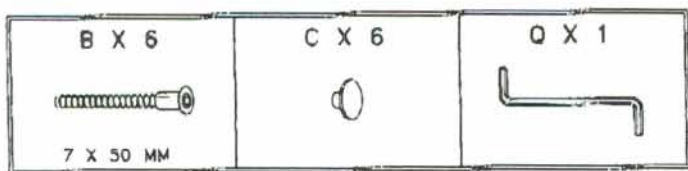



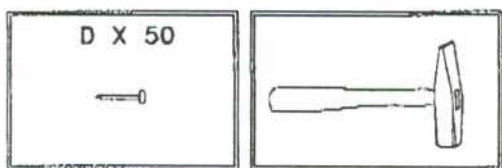
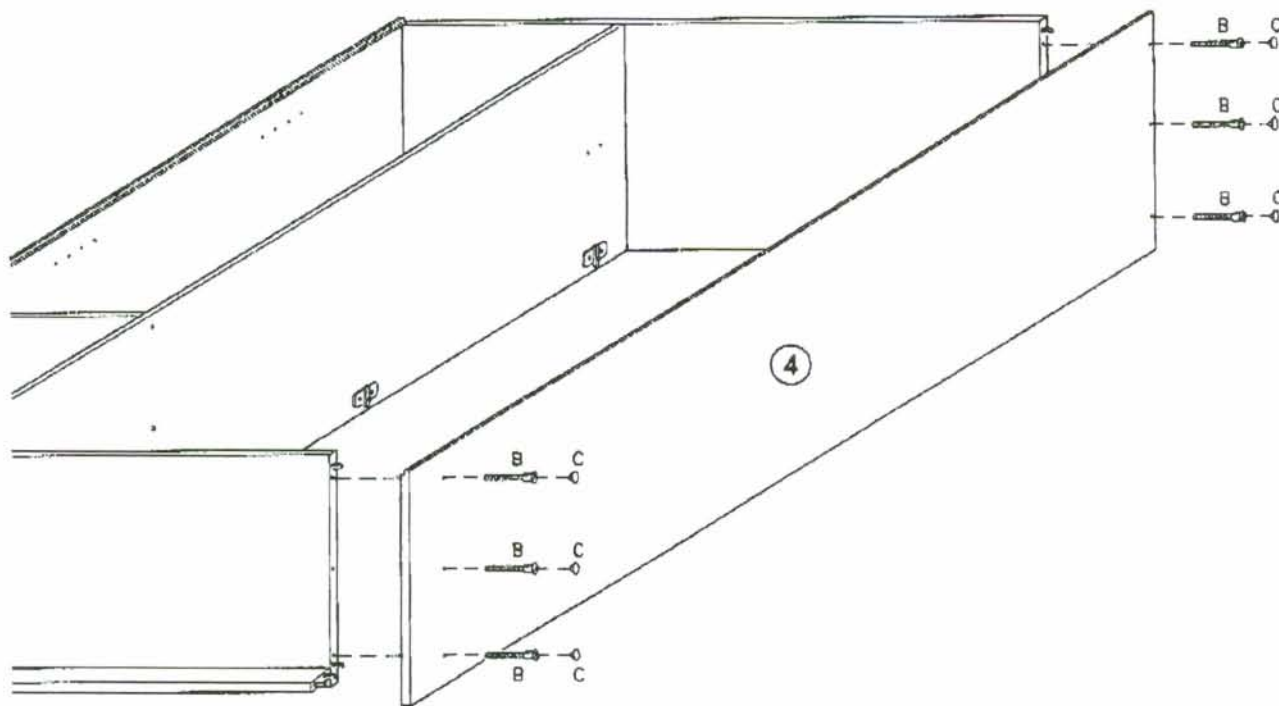



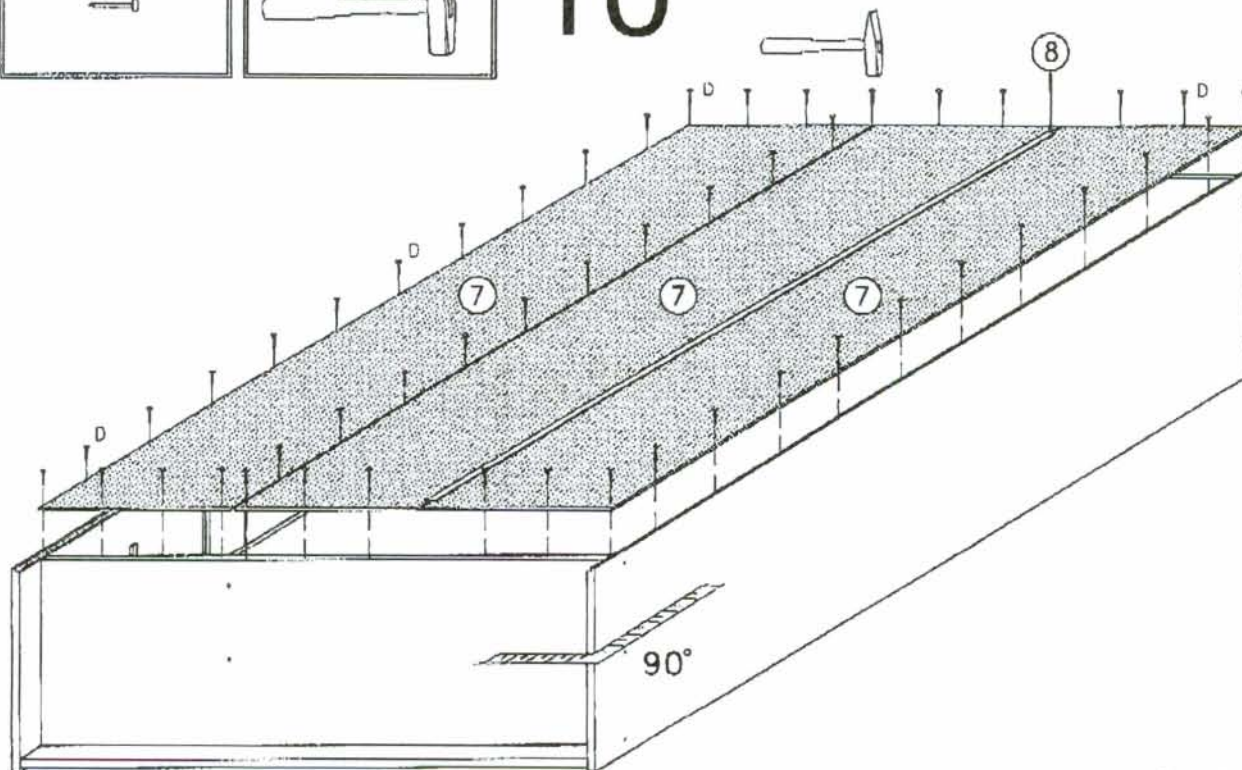

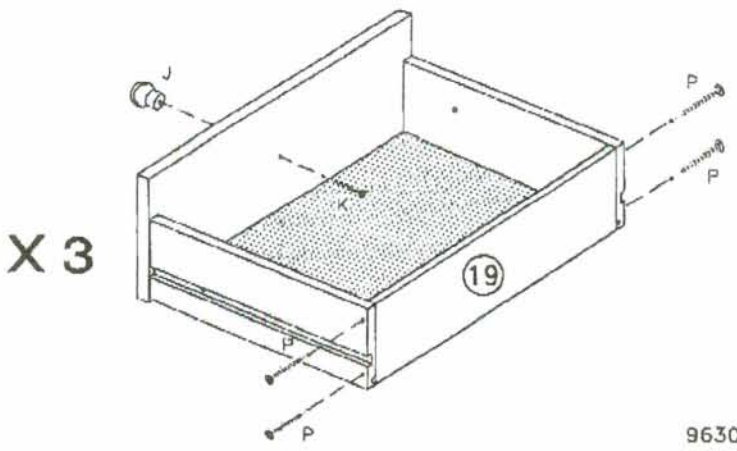
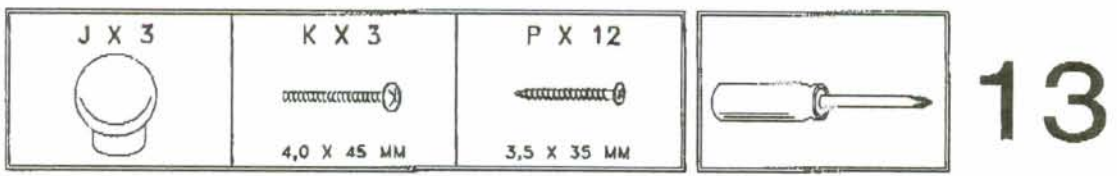
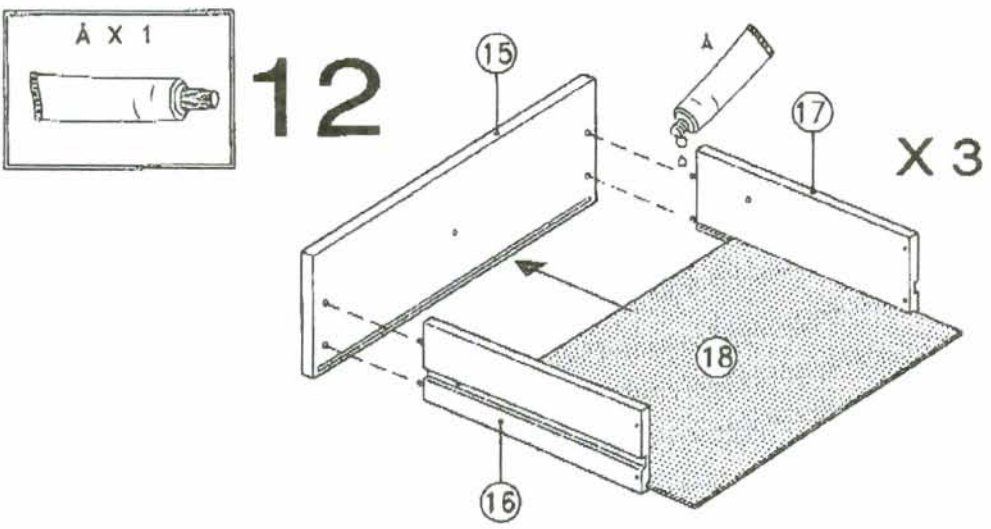
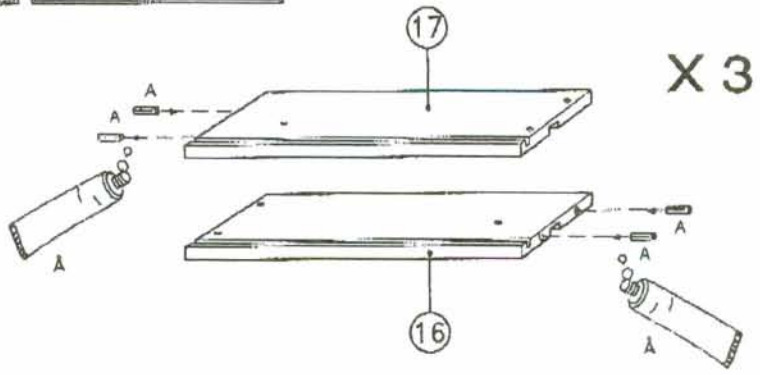
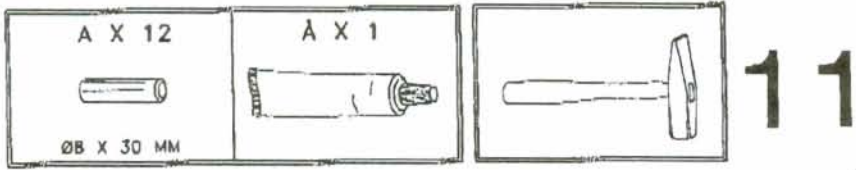

9



10





E X 8 	H X 6  M4 X 11 MM	J X 1 	K X 1  4,0 X 45 MM	N X 2  3,5 X 15 MM
R X 2 	S X 2 	Z X 2 	Ø X 2 	

14

